



- Hey Google
- Hey Siri
- Hey Alexa



**DOMOTICA**  
READY



**APP**  
CONTROL



**WIRELESS**  
REMOTE



**MANUAL**  
CONTROL

## FOREST DESIGN Series

The DS-XL® Series is designed to create visual impact and provides superior functionality and ease of use to the end-user. Available as manual, corded or motorised operated curtain track system.

- FOREST DS®
- FOREST DS-XL®
- FOREST DS-XL® Motorised
- FOREST DS-XL® LED
- FOREST DS-XL® LED Motorised

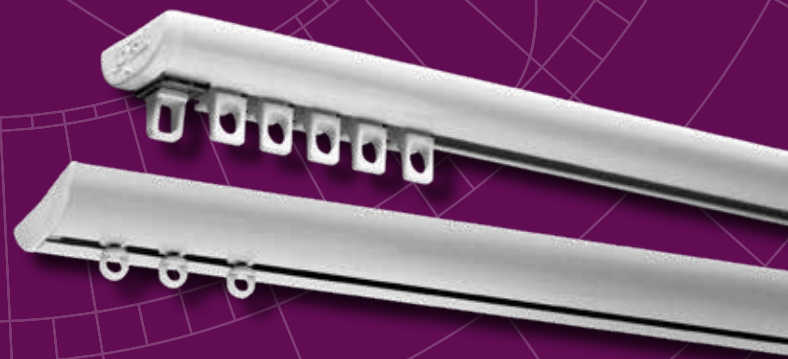

THE WORLD  
BEHIND  
YOUR  
CURTAINS

# FOREST DS® - DESIGN SYSTEM



The DS® curtain track system is for fans of a sleek curtain track. This manually operated curtain track system fits into any stylish interior with an eye for design.

The DS® system has the same dimensions as the Klick System (KS®). This makes it possible to use all KS® assembly components (except the end caps). The height of the track is 11 mm and a “belly” has been created at the front so that the brackets can be mounted out of sight.

The DS® track can also be bent, making it extremely suitable for semicircular bay windows.

## PRODUCT INFORMATION

- Elegant and aesthetically pleasing hand drawn track system;
- For all types of medium weight draperies (max.curtain weight 8kg per meter);
- Colours available: white, silver or black with matching assembly components;
- Available lengths in white: 4, 5, 6 en 7 meter (silver in 4, 5, 6 meter & black in 5 and 7 meter);
- Bendable; designer curtain track can be curved for outside bends only using a 10 cm radius or continuous curved;
- Invisible ceiling brackets to fix track flush to ceiling available;
- Quick installation with “Smart Klick” brackets for wall and ceiling applications;
- Same brackets as used with Klick System;
- Heavy duty clickable carriers - UV protected - for smooth and easy traversing;
- Especially designed for use in combination with Forest Wave System;
- Track finish: chromated powder coating with a factory applied patented dry lubricant;
- Warranty: 10 years.

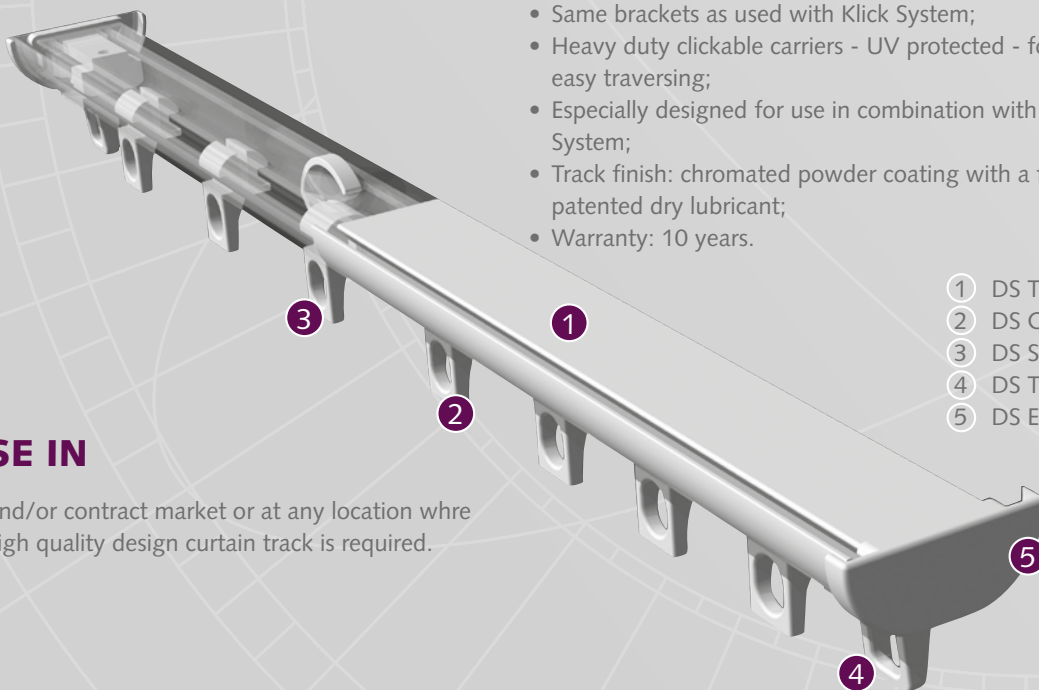

- ① DS Track
- ② DS Carrier
- ③ DS Stop carrier
- ④ DS Twist end stop
- ⑤ DS End cap

## FOR USE IN

Residential and/or contract market or at any location where an elegant high quality design curtain track is required.

## SPECIFICATIONS

- Shown actual size 1:1
- Weight: 170 gr/meter
- Aluminium Extrusion
- Size: 11 x 24 mm
- Colours: white, silver, black

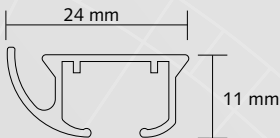

## BENDING / CURVING

The track can be curved and reversed curved using a 10 cm (4") radius. Continuous curving is available by special order form factory only.



## APPLICATIONS

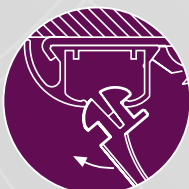
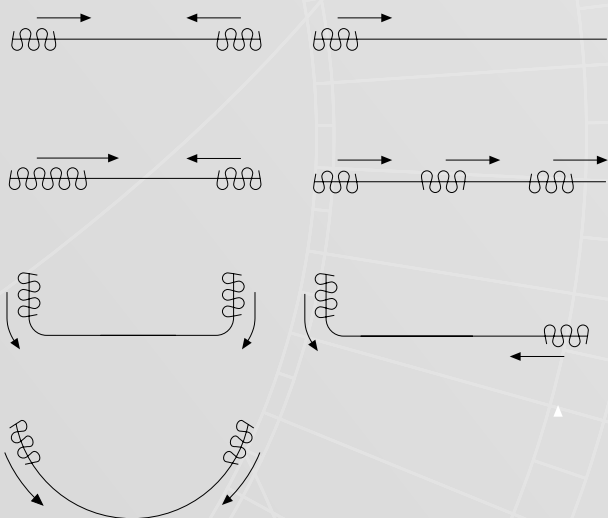

Clickable carrier



Easy installation  
click - position - tighten

## MOUNTING

### Smart Klick Aluminium wall bracket single

- A) 7,5 cm      B) 6,3 cm
- A) 10 cm      B) 8,8 cm

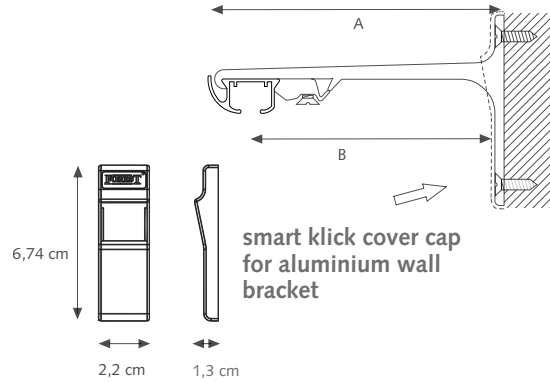

### Smart Klick Aluminium wall bracket double

- A) 15 cm      B) 9,2 cm      C) 4,5 cm
- A) 20 cm      B) 9,2 cm      C) 9,5 cm

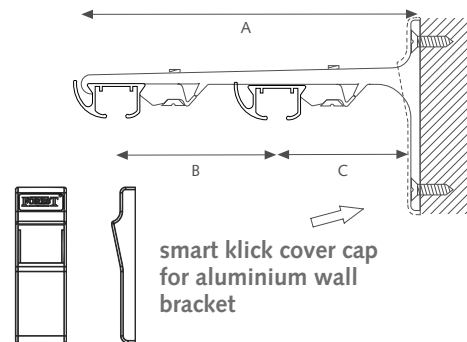

### Smart Klick Aluminium wall bracket triple

- A) 25 cm      B) 9,3 cm      C) 5 cm

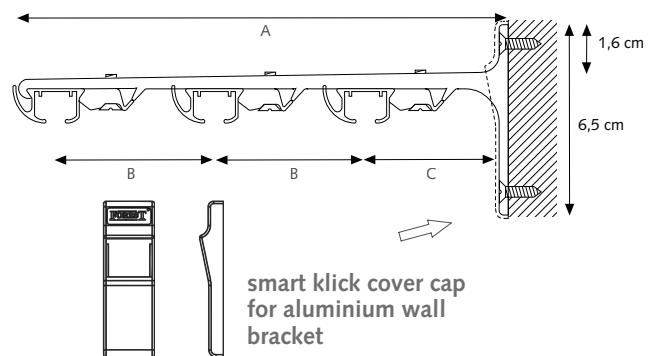

# FOREST DS-XL®



With the DS-XL® Series, Forest offers curtain tracks that optimally combines design and functionality. The Design System XL gives every interior an extra visual appearance.

Stylish curtains deserve an elegant and fashionable curtain track. The DS-XL® Series provide a sleek finish and contribute to a unique design look at home or in any hotelroom.

Thanks to its symmetrical profile the system is suitable for a blind installation against the ceiling, with click or swivel brackets.

Thanks to a symmetrical profile, the system can be mounted "blind" to the ceiling. This provides an extra sleek finish. The track is easy to mount by means of swivel supports or click supports.

The DS-XL® track system has been especially designed for use with our wave system, Forest Wave System. But it can also be made with regular pleated curtain headings. Thanks to its symmetrical profile the system is suitable for a blind installation against the ceiling, with click or swivel brackets.

## FOR USE IN

Hotels, offices, residences, boats, campers, planes or anywhere an efficient and elegant track system is required for curtains and drapes.

## PRODUCT INFORMATION

- Elegant and aesthetical hand drawn and corded curtain track system;
- For all types of medium weight draperies;
- Quick and easy installation;
- Ceiling brackets and wall brackets available;
- Invisible ceiling brackets to fix track flush to ceiling available;
- Heavy duty carriers - uv protected - for smooth and easy traversing;
- Colours available: white, silver or anthracite with matching assembly components;
- Available length: standard stock size 6 meter (19,8");
- Especially designed for use in combination with Forest Wave System.
- Warranty: 10 years



## PROFILE

- Shown actual size 1:1
- Weight: 480 gr/meter
- Aluminium extrusion
- Size: 60 x 15 mm
- Colours: white, silver, anthracite

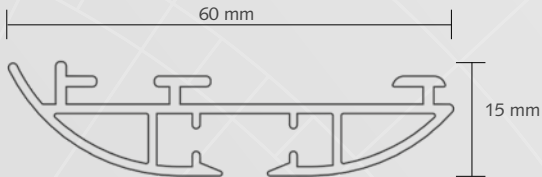

## FOREST WAVE SYSTEM

Opt for a regular pleated heading or choose for a more atmospheric effect for the Forest Wave System. The FMS<sup>®</sup> system has been designed for use with the Forest Wave-system. Our wave system is designed so that the curtains maintain their folding effect from the moment they are dressed.

For more information about Forest Wave System and basic components please refer to our Wave Series brochure..



*Easyflex tape application on DS-XL<sup>®</sup> track*

## COLOUR OPTIONS

De DS-XL<sup>®</sup> is available in three colours: white, silver and anthracite.



# FOREST DS-XL® LED / Motorised



This unique drapery system combines a stylish design with a unique way of lighting. Many designers will work with a lighting plan with three levels: High, especially if the ceiling is vaulted or has been finished with a special material; medium, which includes wall sconces; and low, which means floor lamps and other small lights. Our DS-XL® LED is the solution for a lighting plan on a higher level, integrating our track to create an overall glow on the ceiling.

The DS-XL® LED is an elegant system for all types of medium weight draperies. Available length up to 6 meter in 2 colours: timeless white and in a stylish anthracite finish, making it suitable to fit in every design.

## Create privacy

It also offers the possibility to illuminate the backside and/or the curtain track itself enabling a higher level of privacy.

## SUSTAINABLE LIGHTING

Traditional ways of lighting are very wasteful. Most of the power is wasted in the form of heat. This is why there has been a big push to change the environmental impact of lighting. Another benefit of LED lighting is sustainability and eco-friendliness. The system doesn't use toxic chemicals and it can last for years. It has a life span of approximately 30.000 hours.

## PRODUCT INFORMATION

- Designer track for lighting and curtain track combined;
- Especially designed for Forest Wave application;
- Simple electrical installation by means of clickable connectors;
- Ceiling brackets and wall brackets available;
- One LED strip or two led strips for extra luminosity;
- LED Colour temperature: warm white 3000;
- Low energy consuming LED strip, eco friendly;
- Dimmable LED strips (120 LED's per meter);
- LED Lifespan of 30.000 hours;
- No soldering, clickable components for easy installation without the need for an electrician;
- Power: 15 watt/mtr (4.6 Watt/ft);
- Energy label A+;
- Colours available: white and anthracite;
- The DS-XL® LED Motorised system can be integrated into any building automation system;
- The motorised track system can be installed onto all Forest Shuttle® motors;
- Warranty: 10 years (except LED-lighting).



## SPECIFICATIONS

- Shown actual size 1:1
- Size LED 61 x 20 mm  
Size LED Gemotoriseerd 66 x 25 mm
- Weight LED 580 gr/meter  
Weight LED Gemotoriseerd 675 gr/meter
- Aluminium extrusion
- Colours available: white or anthracite

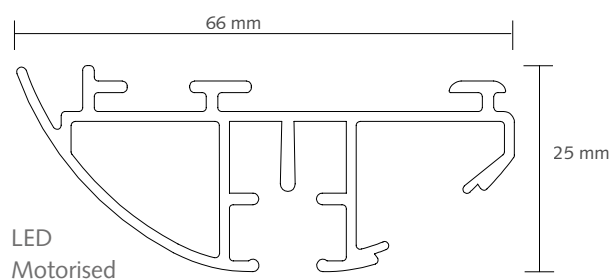
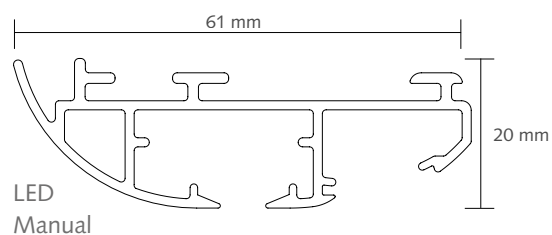

## DS-XL® LED MOTORIZED

The DS-XL® LED Motorised track system is the latest innovation of the Forest Design Series. This brand new drapery system is designed to create visual impact and provides superior functionality and ease of use to the end-user. Controlling the curtains and integrated LED-lighting by remote control or building automation system guarantees a unique experience of atmosphere and comfort in any room.



# FOREST DS-XL® LED Control Options

Our wide range of controls make finding a fit for your home even easier; controlling the curtains by hand, remote or even by building automation system. With the remote you can control the curtains in any position you like. Controlling the motorised curtain system by your smartphone or tablet, you can create and schedule customized room scenes that allow your curtains to operate on their own throughout the day.



## FOREST DIAMOND SENSE REMOTE

15 Channel Remote control, possibility to control up to 15 systems individually and in group by integrated timer function or manual. Auto-On mode, when holding hand above it, the integrated LED light will automatically come on. Radio control, range up to 30 meters. Including magnetic wall support.



## FOREST WI-FI DONGLE

With the Shuttle® Wi-Fi dongle, you can control your motorised curtains with your mobile device by the Forest Connect app or even by voice command with the easy integration in for example Google Home or Amazon Echo without the need for an additional hub or gateway.



## FOREST WIRELESS CONNECTOR

The Forest Wireless Connector is an easy way to make the motorised curtain systems 'smart'. This wireless remote solution works in combination with an analogue timer or a smart plug with which services as Apple HomeKit or Google Assistant or Amazon Alexa become available. It is also easily incorporated into most popular building management systems, including dry contact controls.



## BUILDING AUTOMATION / HOTEL CONTROL

The DS-XL® System can be connected to any Building Automation system, by relay control.

## SMART DEVICE CONNECTIVITY

	Shuttle S/M/L	Shuttle S/M/L/L with Z-Wave	Shuttle iOn	Shuttle AC	Forest Connect app	Google Home	Apple HomeKit	Amazon Alexa	Google Assistant	Apple Siri	Voice control
Forest Wireless Connector One way transmitter to control curtains by third party apps or by Domotics. (433Mhz)	●		●			●	●	●	●	●	●
Forest Wi-Fi Dongle in combination with Forest Connect app	●				●	●		●	●	●	
Smartwares Controller in combination with HomeWizard lite app (433 Mhz)	●		●					●			
Homey in combination with Homey app	●	●	●			●	●	●	●	●	
FIBARO System in combination with FIBARO Home Center app		●		● <sup>1</sup>		●	●	●	●	●	
Samsung SmartThings Hub in combination with Samsung SmartThings app		●				●	●	●	●	●	
230 Volt hard-wired building management system				●							

1) Only with FIBARO Roller Shutter 3 / Walli Roller Shutter

## WORKS WITH



[www.amx.com](http://www.amx.com)



[www.knx.nl](http://www.knx.nl)



[www.z-wave.com](http://www.z-wave.com)













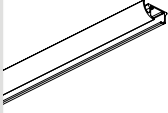
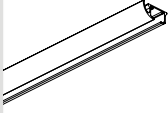



[www.crestron.com](http://www.crestron.com)

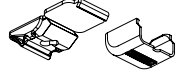
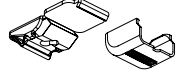

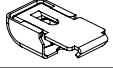
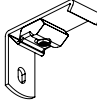
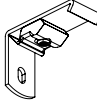
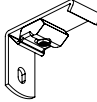





[www.smart-homes.nl](http://www.smart-homes.nl)

Forest DS-XL® is compatible with many other Building Automation systems, thanks to its modular construction. A competitive advantage over the motorised drapery systems in the world!

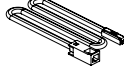
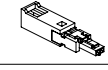
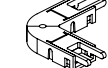
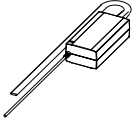

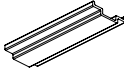

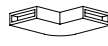
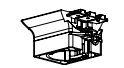
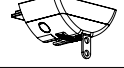
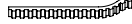

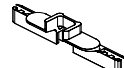











DS	DS-XL	DS-XL CORDED	DS-XL MOTORISED	DS-XL LED	DS-XL LED MOTORISED	DS TRACK + COMPONENTS	ARTICLE	PACKING UNIT	ART.NR
●							DS TRACK WHITE 80 mtr/bundle 100 mtr/bundle 120 mtr/bundle 140 mtr/bundle	4 mtr 5 mtr 6 mtr 7 mtr	2001001400 2001001500 2001001600 2001001700
●							DS RAIL SILVER 80 mtr/bundle 100 mtr/bundle 120 mtr/bundle	4 mtr 5 mtr 6 mtr	2001003400 2001003500 2001003600
●							DS RAIL BLACK 100 mtr/bundle 140 mtr/bundle	5 mtr 7 mtr	2001006500 2001006700
●							CARRIER ASYMMETRICAL Clickable, UV-resistant plastic, 10 carriers on a breakaway strip. (also symmetrical carriers available).	500/box white silver black	1010001000 1010003000 1010006000
●							CARRIER SYMMETRICAL	500/box white	1010101000
●							STOP CARRIER Clickable, UV-resistant plastic	250/box white silver black	1010201000 1010203000 1010206000
●							DS TWIST ENDSTOP WITH CAP UV-resistant plastic with metal plate. "Twists" into track	100/box white silver black	2016301000 2016303000 2016306000
●							CEILING BRACKET Slides onto the track, powder coated. Regular duty	100/box white silver black	1018001000 1018003000 1018006000
●							PLAFONDSTEUN WITH SLOT Slides onto the track, powder coated. Regular duty Slotted support makes fixing curtain track easier	100/box white silver black	1018101000 1018103000 1018106000
●							SMART KLICK CEILING BRACKET Powder coated, "klicks" onto track. Attach with VK-4 mm screw.	100/box white silver black	1018201000 1018203000 1018206000
●							SMART KLICK CEILING BRACKET INCL. COVER CAP	white silver black	1018201001 1018203001 1018206001
●							COVER CAP FOR SMART KLICK BRACKETS Suitable for Smart Klick Wall-and Ceiling bracket	white silver black	1019201000 1019203000 1019206000
●							SMART KLICK CEILING BRACKET + SLOT Slotted support makes fixing curtain track easier	100/box white Available in Q3/4 2020	1018151000
●							SMART KLICK WALL BRACKET 3,5 cm "Klicks onto track, powder coated. One screw attachment. For light weight use only.	50/box white silver black	1020201035 1020203035 1020206035
●							SMART KLICK WALL BRACKET 6 cm "Klicks onto track, powder coated. One screw attachment. For light weight use only.	white silver black	1020201060 1020203060 1020206060
●							SMART KLICK WALL BRACKET 7,5 cm "Klicks onto track, powder coated. One screw attachment. For light weight use only.	white silver black	1020201075 1020203075 1020206075
●							ALUMINIUM SK WALL BRACKET 7,5 CM SINGLE. "Klicks onto track, powder coated. .	20/box white silver brown	1020301075 1020303075 1020305075
●							ALUMINIUM SK AFSTANDSTEUN 10 cm ENKEL. "Klicks onto track, powder coated. .	20/box black white silver	1020306075 1020301100 1020303100
●							ALUMINIUM SK AFSTANDSTEUN 15 cm DUBBEL. "Klicks onto track, powder coated. .	15/box black white silver	1020306100 1020301150 1020303150
●							KS ALUMINIUM SK AFSTANDSTEUN 20 cm DUBBEL. "Klicks onto track, powder coated.	15/box brown black white	1020305150 1020306150 1020301200
●							ALUMINIUM SK AFSTANDSTEUN 25 cm TRIPLE. "Klicks onto track, powder coated.	10/box silver black white	1020303200 1020306200 1020301250
●							SMART KLICK COVER CAP ALUMINIUM BRACKET UNIVERSAL	50/box white silver black	1021301000 1021303000 1021306000

DS	DS-XL	DS-XL CORDED	DS-XL MOTORISED	DS-XL LED	DS-XL LED MOTORISED	DS-XL/ DS-XL LED/ DS-XL (LED) MOTORISED + COMPONENTS	ARTICLE	PACKING UNIT	ART.NR
	●	●					DS-XL TRACK, 6 mtr (19"8")	24mtr/bundle	white silver anthracite 3916101600 3916103600 3916106600
			●				DS-XL TRACK MOTORISED, 6 mtr In combination with Shuttle L motor	6mtr/bundle	white anthracite 5515501600 5515506600
				●			DS-XL LED TRACK MANUAL	6mtr/length	white anthracite 5917501600 5917506600
					●		DS-XL LED TRACK MOTORISED, 6 mtr In combination with Shuttle S motor & the Shuttle M adaptor	6mtr/length	white anthracite 5915501600 5915505600
	●	●	●	●	●		ECONOMY CARRIER SMALL	500/box	white black 3910101000 3910106000
	●	●	●	●	●		DS-XL END STOP	100/box	3916001000
	●						DS-XL ENDCAP	20/box	white silver black 3916101000 3916103000 3916106000
		●					DS-XL ENDCAP CORDED	20/box	white silver black 3916201000 3916205000 3916206000
				●			DS-XL LED ENDCAP	20/box	white black 5916501000 5916506000
				●			DS-XL LED END CAP FLAT	20/box	white black 5916501002 5916506002
	●			●	●		DS-XL KLICK CEILING BRACKET	100/box	3918301000
	●			●	●		DS-XL CEILING SWIVEL BRACKET	100/box	white anthracite 3818200230 3818205230
	●			●	●		DS-XL WALL BRACKET 9 CM	5/box	white anthracite 3820001018 3820005018
	●			●	●		DS-XL TRACK CONNECTOR STRAIGHT	10/box	3916401000
	●			●			DS-XL TRACK CONNECTOR 90 DEGREES	10/box	3916401001
				●	●		DS-XL LED STRIP 3045 3000K/ 24V/ 9.6W/m 8mm width	50mtr/roll	5917503045-R1
				●			DS-XL LED CONNECTOR STRAIGHT	10/box	5917502400
				●	●		DS-XL LED CONNECTOR CABLE 2MTR EXTENSION CABLE	1/box 1/box	black (200cm/24v) black (200cm/24v) 5917502420 5917512420
				●	●		DS-XL LED DIMMER In combination with Shuttle M adaptor	1/box	white black 5917531470 5917536470
				●	●		DS-XL LED STRIP 3045 POWER SUPPLY CABLE 200cm / 24Vdc DS-XL LED Dimmer accessory	1/piece	white black 5917502421 5917502422

DS	DS-XL	DS-XL CORDED	DS-XL MOTORISED	DS-XL LED	DS-XL LED MOTORISED	DS-XL/ DS-XL LED/ DS-XL (LED) MOTORISED + COMPONENTS	ARTICLE	PACKING UNIT	ART.NR
				●	●		DS-XL LED STRIP 3045 EXTENSION CABLE 200cm / 24Vdc DS-XL LED Dimmer accessory	1/piece white black	5917512421 5917512422
				●	●		DS-XL LED STRIP CONNECTOR PLUG DS-XL LED Dimmer accessory	1/piece	5917524515
				●	●		DS-XL LED STRIP 3045 CONNECTOR 90 DEGREE DS-XL LED Dimmer accessory	10/box 24v	5917502491
				●	●		ADAPTOR SET SHUTTLE M (icm DS-XL LED Dimmer) Incl. cable & holder EU 0.50 mtr EU 3.00 mtr UK 0.50 mtr USA 0.50 mtr EU 0.50 mtr	1/box white white white white black	5201002002 5201002003 5201002004 5201002007 5201006002
			●				DS-XL LED STRIP ANTHRACITE To cover the LED-channel when not in use	6mtr/bundle anthracite	5916505000
				●			DS-XL LED STRIP OPAAL - MIDDEL	6mtr/bundle	5916509001
				●	●		DS-XL LED STRIP MOUNTING DEVICE	1/box	5916509999
				●			DS-XL LED STRIP CONNECTOR 90 DEGREE	10/box	5917502490
			●		●		DS-XL LED MOTORISED MOTOR PULLEY, 6 mtr	1/box white black	5917011000 5917076000
			●		●		DS-XL LED MOTORIZED RETURN PULLEY, 6 mtr	1/box white black	5917011100 5917016100
			●		●		FMS TRANSPORT BELT Toothed belt, to be installed inside the FMS Track	100mtr/roll	5105501000
			●		●		FMS BELT CONNECTOR Connects the Master Carrier with the transport belt	50/box white silver black	5103011500 5103013500 5103016500
			●		●		MRS BELT CONNECTOR Connects the Master Carrier with the transport belt	25/box	4805711500

DS	DS-XL	DS-XL CORDED	DS-XL MOTORISED	DS-XL LED	DS-XL LED MOTORISED	FOREST WAVE ONDERDELEN	ARTICLE	PACKING UNIT	ART.NR
●							WAVE DS ENDKCAP + SCREW To be screwed with an Easywave carrier, made of UV-resistant plastic for wave	100/box white silver black	4816101000 4816103000 4816106000
			●		●		EASYFLEX MASTER CARRIER 90 GRADEN LEFT voor center draw  90° left for small stiffener	25/box white silver black  white	4815351090 4815353090 4815356090  4815361090
			●		●		EASYFLEX VOORLOPER 90 GRADEN RECHTS voor middensluitend pakket  90° right for small stiffener	15/box white silver black  white	4815451090 4815453090 4815456090  4815461090
	●	●		●			EASYFLEX PLASTIC VOORLOPER 90 GRADEN	15/box white black	3916701000 3916703000 3916706000

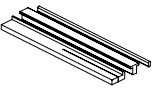
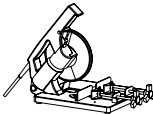
DS	DS-XL	DS-XL CORDED	DS-XL MOTORIZED	DS-XL LED	DS-XL LED MOTORIZED	CONTROL COMPONENTS + OTHER ITEMS	ARTICLE	PACKING UNIT	ART.NR
		●					DS-XL CORD CONNECTOR	100/box	white silver black 1530301000 1530303000 1530306000
		●					CORD 3 MM ON ROLL	200mtr/roll	white silver black 3830401000 3830403000 3830406000
		●					TENSION PULLEY	25/box	white 1030501000
		●					CORD/CHAIN WALL MOUNT SAFETY BOX SINGLE	25/box	3645702000
		●					CORD/CHAIN WEIGHT DESIGN 110 GR WIT	10/box	white silver black 3030701000 3030703000 3030706000
			●		●		FOREST DIAMOND SENSE REMOTE CONTROL	1/box	white black 5201091470 5201096470
			●		●	 	FOREST WIFI DONGLE Incl. cable WiFi 2.4GHz Power supply 12V DC 300mA max USB power 5V DC 1000mA max Control the curtains with Forest Connect App Bidirectioneel	1/box	white black 5201002280 5201006280
			●		●		FOREST WIRELESS CONNECTOR Incl. 15cm USB cable, excl. usb-adaptor Eenweg communicatie zender waarmee het mogelijk is via een smartplug gordijnen te bedienen via apps van Google/Apple of via Domotica	1/box	white 5201002270
			●		●		FOREST WIRELESS CONNECTOR USB ADAPTOR	1/box	EU UK AU US 5201002271-EU 5201002271-UK 5201002272-AU 5201002274-US
			●		●		FOREST WIRELESS WALL SWITCH 2-channel wall switch Sizes: 8.5 x 8.5 x 1 cm	1/box	white black 5201001480 5201006480

DS	DS-XL	DS-XL CORDED	DS-XL MOTORIZED	DS-XL LED	DS-XL LED MOTORIZED	BENDING COMPONENTS	ARTICLE	PACKING UNIT	ART.NR
●							COMPACT BENDING HOUSE For DS	1/each	1050000000
							DS BENDING WHEEL ALL-IN incl. strips (60cm)	1/each	1050100000
●							ELECTRIC POWERED BENDER For creating continuous curves. Minimum radius 50 cm. Inclusive 3 DS wheels and bending strip.	1/box	230 volt EU 1060500000
●							DS BENDING WHEELS Set of 3 bending wheels for electric powered bender. Only suitable for DS track.	1/set	2060700000
●							DS T-BENDING STRIP SET ELECTRIC For DS electric powered bender, Length of 60 cm.	1/piece	7m 8500000000
●	●		●				ELECTRIC POWERED RAILCUTTER Sawing machine for all thin-walled aluminum profiles. Also for miter cuts.	1/piece	230 volt EU 1061100000
							REPLACEMENT BLADE For electric powered railcutter.	1/piece	1061200000